



Powerpole® Connectors

PP75 - Up to 120 Amps



PP75 with Mounting Wings

PP75 series Powerpole® housings can be used for wire-to-wire, wire-to-board, and wire-to-busbar applications. Wire sizes from 16 to 6 AWG (1.3 to 13.3 mm²) offer power capabilities up to 120 amps per pole. Locking housings offer the capability to secure Powerpole® housings to each other and to mounting pads. Housings made from chemical resistant (CR) resin withstand industrial solvents better than standard housings.

Large Wire Range Accommodates up to 6 AWG (10 mm²) Wire

Reducing bushings allow as small as 16 AWG (1.5 mm²) wire to be used

Wire, PCB, and Busbar Contacts

Allows one connection system to meet multiple needs

Mini-Powerclaw PCB Contacts Minimize PCB Footprint

Removes the PP75 housing from the board side

PP75 ORDERING INFORMATION

PP75 Standard Housings

The second smallest Powerpole® housing can be used with wire contacts up to 6 AWG (10 mm²) as well as PCB and busbar contacts.

Description	Part Numbers	
Minimum Quantity	1,000	100
Red	5916G7-BK	5916G7
Green	5916G6-BK	5916G6
Black	5916G4-BK	5916G4
White	5916G5-BK	5916G5
Blue	5916-BK	5916
Yellow	5916G15-BK	5916G15
Orange	5916G14-BK	5916G14
Gray	5916G16-BK	5916G16

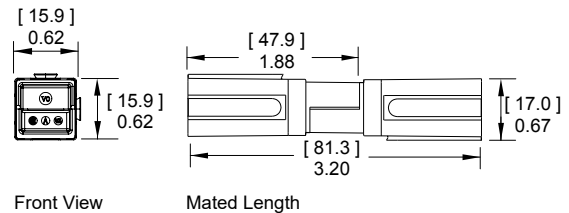

PP75 Chemical Resistant (CR) Housings

Has the same form and dimensions of the standard PP75 housing in a chemical resistant PBT / PC blend housing. Suitable for use to -40°C.

Description	Part Numbers	
Minimum Quantity	1,000	
Red	P5916G7-BK	
Black	P5916G4-BK	
White	P5916G5-BK	
Blue	P5916-BK	

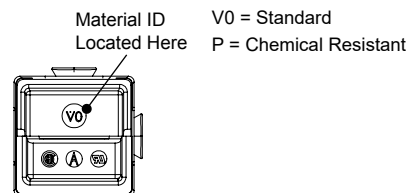

PP75 Locking Dovetail Housings

Offers dovetails for stacking housings that have a locking feature to prevent housings separating. Can mate to standard and chemical resistant housings, but cannot be stacked with them.

Description	Part Numbers	
Minimum Quantity	1,000	100
Red	75LOKRED-BK	75LOKRED
Green	75LOKGRN-BK	75LOKGRN
Black	75LOKBLK-BK	75LOKBLK
White	75LOKWHT-BK	75LOKWHT
Blue	75LOKBLU-BK	75LOKBLU
Gray	75LOKGRA-BK	75LOKGRA

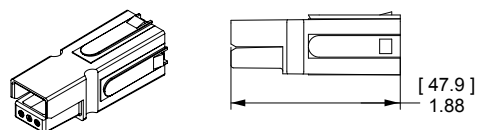

PP75 Premate Ground Housings

Offers a first-mate, last-break connection when stacked together with PP75 housings. Stacks together with PP75 standard and chemical resistant housings. Housings are mechanically keyed to prevent cross mating with power positions.

Description	Part Numbers	
Minimum Quantity	1,000	100
Green	5927G6-BK	5927G6

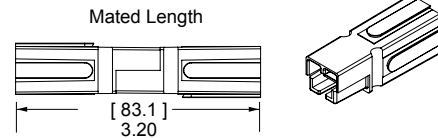

PP75 Silver Plated Wire Contacts

Silver plated contacts offer the best electrical performance and durability up to 10,000 mating cycles. See reducing bushings in accessory section for smaller wires.

AWG	mm ²	Mating Force	Loose Piece Part Numbers		Dimensions	
					- A - inches	mm
Minimum Quantity					1,000	100
6	13.3	Low	1307-BK	1307	0.22	5.59
6	13.3	High	5900-BK	5900	0.22	5.59
8	8.4	High	5952-BK	5952	0.19	4.83
12 to 10	3.3 to 5.3	Low	5953-BK	5953	0.14	3.56
12 to 10	3.3 to 5.3	High	5915-BK	5915	0.14	3.56

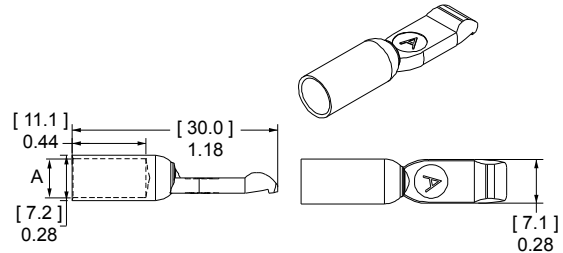

PP75 Premate Ground Wire Contacts

Silver plated contacts for use with the PP75 Premate Ground Housing. Rated to 10,000 mating cycles.

Type	AWG	mm ²	Loose Piece Part Numbers		Dimensions	
					- A - inches	mm
Minimum Quantity					1,000	100
Individual	6	13.3	1875G1-BK	1875G1	0.22	5.59
Individual	8	8.4	1875G2-BK	1875G2	0.19	4.83
Individual	12 to 10	3.3 to 5.3	1875G3-BK	1875G3	0.14	3.56

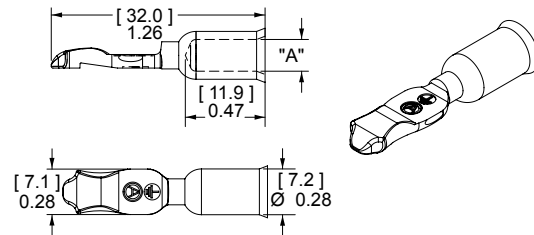

PP75 Silver Plated Busbar Contacts

Provide a quick disconnect input or output busbar connection. Busbar contacts are for mating with wire contacts only. Part number 75BBS includes lock nuts. Locknuts must be ordered separately for B01915P1.

Type	Thread	Mating Force	Part Numbers				
Minimum Quantity					1,000	20	10
Busbar	10-24	High	B01915P1	-	75BBS		
Lock Nut	10-24	-	H1216P8	-	-		

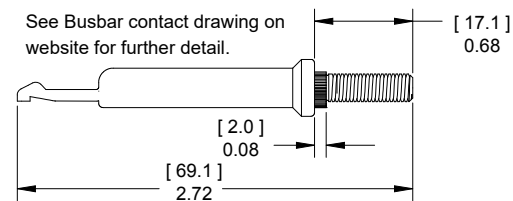

55A Right Angle Standard Powerclaw PCB Contacts

Standard Powerclaw contacts are for use inside a PP75 housing and provide a color-coded right angle connection to the PCB.

Description	Loose Piece Part Numbers	
Minimum Quantity	500	100
Tin Plated	PC5930T-BK	PC5930T
Silver Plated	PC5930S-BK	PC5930S

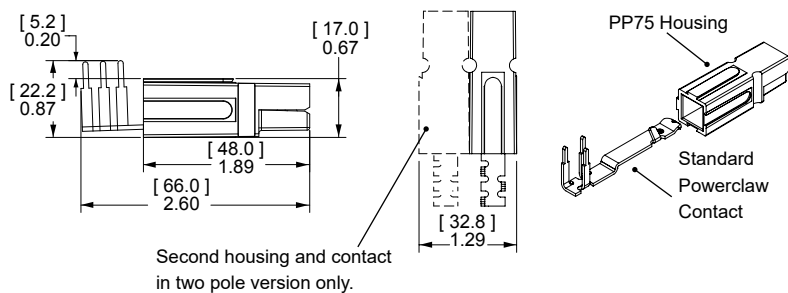

See PCB contact drawing on website for further detail.

Second housing and contact in two pole version only.

55A Right Angle Mini Powerclaw PCB Contacts

Right angle Mini Powerclaw contacts can be used on the PCB edge without a PP75 housing on the PCB side. A self polarizing design allow PP75 wire housings to mate to PCB contacts one way.

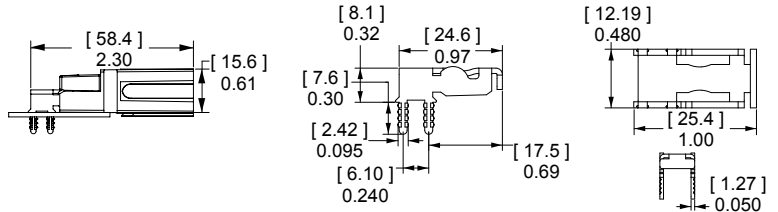

Description	Loose Piece Part Numbers	
Minimum Quantity	1,000	100
Tin Plated	PC5934T-BK	PC5934T
Silver Plated	PC5934S-BK	PC5934S

55A Vertical Mini Powerclaw PCB Contacts

Vertical Mini Powerclaw contacts save space by not requiring a PP75 housing on the PCB side. The guide housing is required for 2 pole applications to provide a polarized connection. (See PP75 accessories).

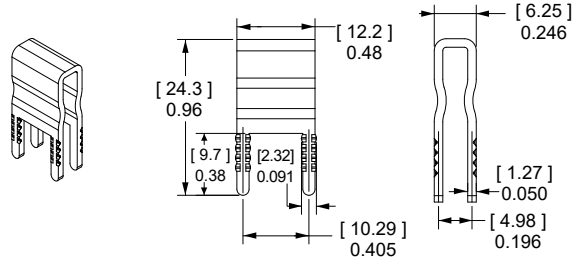

Description	Loose Piece Part Numbers	
Minimum Quantity	1,500	100
Tin Plated	PC5933T-BK	PC5933T
Silver Plated	PC5933S-BK	PC5933S

See PCB contact drawing on website for further detail.

PP75 CONNECTOR TEMPERATURE CHARTS - Temperature rise charts are based on a 25°C ambient temperature.

Current - Temperature Derating per IEC 60512-5-2 Test 5B

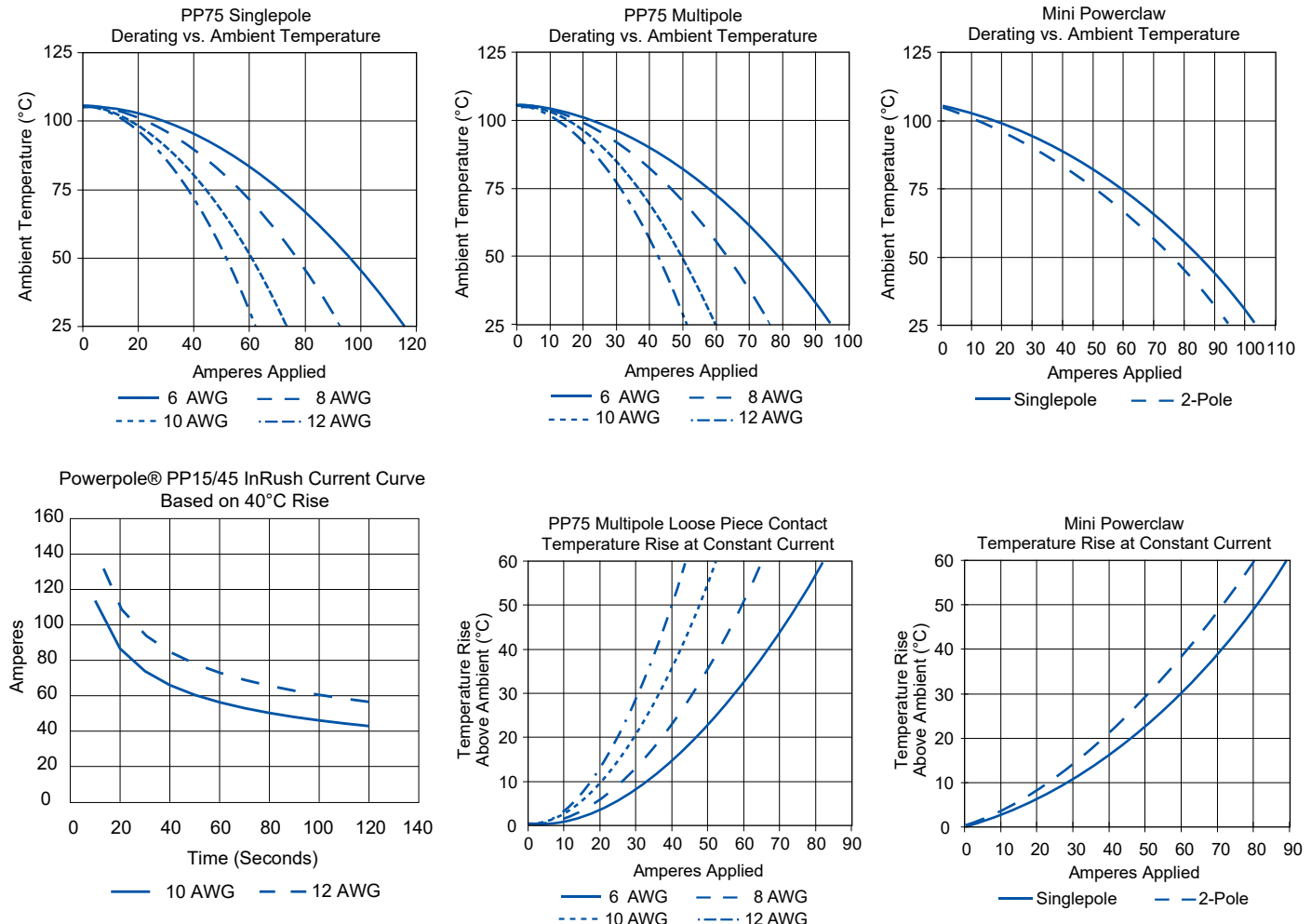

NOTE: Powerclaw charts are based on 8 AWG equivalent copper foil on board side, mated to 6 AWG conductor on wire side.

PP75 SPECIFICATIONS

ELECTRICAL		
Current Rating Amperes ¹	UL 1977	CSA
Wire-to-Wire (6 AWG)	120	70
Wire-to-PCB (6 AWG)	55	50
Wire-to-Busbar (6 AWG)	75	
Voltage Rating AC/DC		
UL 1977	600	
PCB Connector Recommended Voltage ³		
per IEC 60950-1 Table 2L Pollution Degree ²		
Mini Vert. Contact Adjacent Poles	220	
Mini Horiz. Contact Adjacent Poles	200	
Standard Contact Adjacent Poles	635	
Dielectric Withstanding Voltage		
Volts AC	2,200	
Avg. Mated Contact Resistance Milliohms ¹		
Wire Contact with 1 1/4" to 6 AWG	0.200	
PCB Contact-to-Contact	0.500	
UL Hot Plug Current Rating Amperes - 250 Cycles at 120V DC ⁶		
Wire-to-Wire	50A	
PCB- to-Wire (Vertical Mini Powerclaw)	40A	
UL Ground Short Time Current Test - 75A Premate Ground		
1530 Amps, 6 AWG Wire	6 Seconds	

MATERIALS	
Housing	
Standard Plastic Resin	Polycarbonate
Chem. Resistant Resin	Polycarbonate / PBT blend
Contact Retention Spring	Stainless Steel
Housing Flammability Rating	
UL94	V-0
Glow Wire	960°C (GWFI) / 800°C (GWIT)
Contact	
Base	Copper Alloy
Wire Plating	Silver
PCB Plating	Sn or Ag over Ni
Contact Termination Methods	
Crimp ⁴	Wire Contacts
Hand Solder	Wire and PCB Contacts
Solder Dip	PCB Contacts
Wave Solder	PCB Contacts
Wrench / Socket	Busbar Contacts

MECHANICAL		
Wire Size Range	AWG	mm²
Wire Contacts with Bushings	16 to 6	1.3 to 13.3
Max. Wire Insulation Diameter	in.	mm
	0.437	11.100
Operating Temperature ²	°F	°C
Standard & Ground	-4° to 221°	-20° to 105°
Chemical Resistant*	-40 to 221°	-40° to 105°
*Chemical resistant material not available for PCB guide housings		
Mating Cycles No Load by Plating	Silver (Ag)	Tin (Sn)
Wire and PCB Contacts	10,000	1,500
Avg. Mating / Unmating Force	Lbf.	N
Wire-to-Wire Low Force Contacts	5	22
Wire-to-Wire High Force Contacts	7	31
Standard Powerclaw to Wire	7	31
Mini Powerclaw to Wire	4	17
PCB Specifications		
Mounting Style	Plated Through Hole	
Max PCB Thickness - in. (mm)	Standard: 0.15 (3.81) Mini: 0.25 (6.35)	
Recommended Traces	8 AWG Cross Section	
Min. Contact / Spring Retention Force	Lbf.	N
Wire Housing	50	222
Min. Creepage / Clearance Distance PCB	in.	mm
Standard Powerclaw Adjacent Poles	0.260	6.6
Mini Vert. Powerclaw Adjacent Poles	0.087	2.2
Mini Horiz. Powerclaw Adjacent Poles	0.079	2.0
Mechanical Shock ⁵		
MIL-STD-202	213 Condition A	50g's
Vibration High Frequency ⁵	204 Condition A	10g's



NOTE 1: See IEC 60664-1 for working voltage.

NOTE 2: Amp ratings are stated per position and based on all positions being fully loaded.

1 - Based on: 105°C rated or better cable of the largest size. Properly calibrated Anderson Power™ recommended tooling, and a 25°C ambient temperature. UL rating not to exceed the maximum operating temperature. CSA rating below a 30°C temperature rise.

2 - Limited by the thermal properties of the connector plastic housing.

3 - Without use of spacers to increase creepage and clearance distances.

4 - Use Anderson Power™ recommended tooling only. Alternate tools may adversely affect the performance of our connectors along with UL and CSA recognition.

5 - Tested with contact part number 5900.

6 - Based on 2 housings blocked together.

IEC INFORMATION

Connector Series	Configurations	Creepage / Clearance per IEC 60950-1	Material Group
PP75	Single Pole	Unmated	2.97 mm
		Mated	2.97 mm
	Stacked Powerpole®	Unmated	2.97 mm
		Mated	2.97 mm
			IIIa

ATTRIBUTES	PP75
AMP Rating AC/DC	75
Voltage Rating AC/DC (Steady State)	250 V AC/DC (Operational)
Breaking Capacity - AMP Rating / Cycles	75 Amp / 10 Cycles
Voltage Rating (Breaking Capacity)	220 VDC
FINGER Safety - Mated Only	IEC 60529 - IP20
Wire Size Tested	16 mm ²
Contact Series Tested	5900
Climatic Testing (Cold, Heat & MFG)	IEC 60512 Test-11j, 11i & 11g
Cycle Life	IEC 60512 Test 9a - 5,000 Cycles
Mechanical Strength Impact	IEC 60512-5 @ 29.5 Inches - Dropped 8 Times
Temperature Range	-20°C to 105°C -4°F to 221°F

PROTECTION

Touch Safety with Wire Contacts
IEC 60529 IP10



POWERPOLE® PP75 ACCESSORIES

Strain Relief Grommets

Use for strain relief in the back side of a PP75 housing. Wire gauge given for reference only, use grommet ID and wire OD to determine suitability in the end application.

Description	Part Numbers	Dimensions	
		- A -	
		inches	mm
Minimum Quantity	100		
6 AWG, Black	114411P2	0.35	8.89
8 AWG, Black	114411P1	0.25	6.35
10 to 12 AWG, Black	114411P3	0.17	4.32

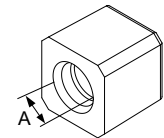

Mounting Wing for Standard or CR Housings

Mounting wings can be used to secure dovetailed Powerpole® 75 series housings by passing fasteners through the wings in either a horizontal or vertical orientation. Useful for sheet metal panels, printed circuit boards, and many other mounting surfaces. Fasteners not included.

Description	Part Numbers
Minimum Quantity	1,000 100
Blue, Round Hole	1399G20-BK 1399G20
Blue, Oval Hole	1399G7-BK 1399G7

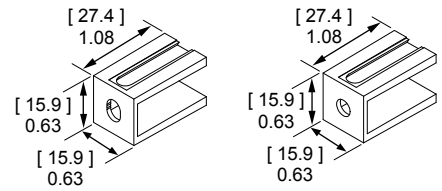

Mounting Wing for Locking Housings

Mounting wings can be used to secure Powerpole® 75 series housings with locking dovetails by passing fasteners through the wings in either a horizontal or vertical orientation. Useful for sheet metal panels, printed circuit boards, and many other mounting surfaces. Fasteners not included.

Description	Part Numbers	
Minimum Quantity	1,000	100
Blue, Oval Hole	75LOKWNGBLU-BK	75LOKWNGBLU
Blue, Round Hole	75LOKWNGBLU-R-BK	75LOKWNGBLU-R

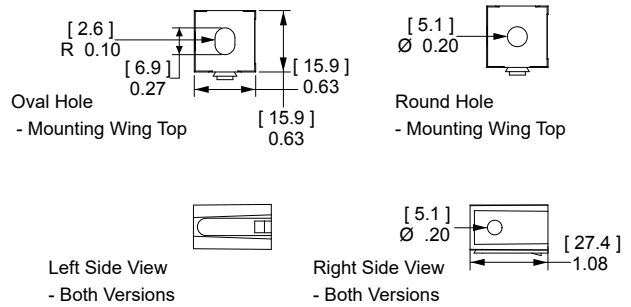

Surface Mount for Locking Housings

Use to secure Powerpole® 75 series housings with locking dovetails to a flat surface. Useful for sheet metal panels, printed circuit boards, and many other mounting surfaces. Fasteners not included.

Description	Part Numbers	
Minimum Quantity	1,000	100
Blue	75LOKSMTBLU-BK	75LOKSMTBLU

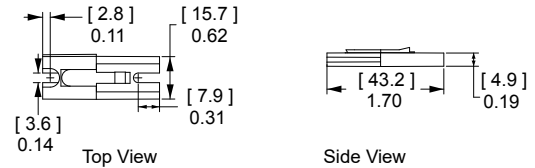

Spacer

Use to separate housings under high power to minimize power capability derating due to heat rise. They are recommended for squaring off a block of Powerpole® 75 housings to enable mounting accessories or retaining pins to be used. Combining long and short spacers opposite each other in a mated block adds keying features, or use two short spacers to avoid interference.

Description	Part Numbers	
Minimum Quantity	1000	100
Red, Short	1399G23-BK	1399G23
Red, Long	1399G21-BK	1399G21

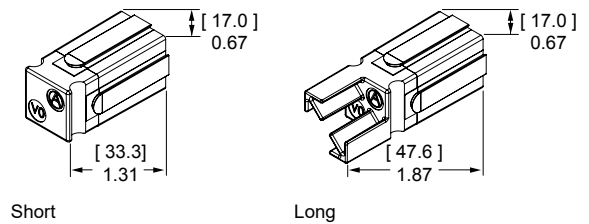

Guide Housings for Vertical Mini Powerclaw Contacts

Prevents polarity being reversed when a two pole PP75 block is mated to vertical mini Powerclaw contacts. Fastening hardware not included.

Description	Part Numbers	
Minimum Quantity	1,000	100
Black Guide Housing	PC-HSG-PP-BK	PC-HSG-PP

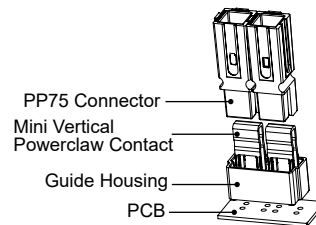

Mounting Clamp

Mounting clamps can be used for fastening a block of Powerpole® 75 series housings to a panel. Connector blocks must be a complete square for the clamps to work properly. Fastening hardware not included.

Description	Part Numbers	
Minimum Quantity	50 sets of 2	
2 or 4 Pole	1463G1	
3 or 6 Pole	1463G2	

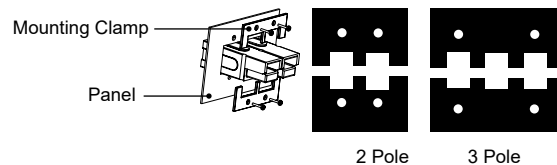

Retaining Pins

Retaining pins are used to keep stacked Powerpole® 75 series housings from separating.

Retaining pins are inserted in the circular opening between two housings stacked side by side.

Dimension B is +/- 0.015 in or 0.38 mm.

Description	Part Numbers		Dimensions			
			- A -		- B -	
			inches	mm	inches	mm
Minimum Quantity	1,000	100				
1 Block High	111812P7	110G19	0.196 / 0.207	4.98 / 5.26	0.560	14.220
2 Block High	111812P6	110G18	0.196 / 0.207	4.98 / 5.26	1.000	25.400

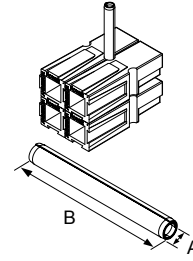

PCB Mounting Staples

Reduce strain on solder joints during mating and unmating. Staples bend over the underside of the PCB board to lock the housings in place. Staples are an interference fit with housings.

Part Number	Number of Stacked Powerpole® H x W
Minimum Quantity	100
PCSTAPLE-2	1 x 2

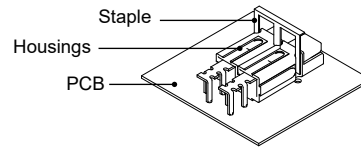

Slide staple over housings and into the holes in the board.



Fasten the staple by bending the leads on the bottom of the board.

Silver Plated Reducing Bushings

Use with contact part number 5900-BK or 1307-BK to allow a smaller wire to be used with the connector. Electrical capability is derated with smaller wire.

Contact Barrel Size		Wire Size		Part Numbers		Dimensions				
						- ID -		- Length -		
AWG	mm ²	AWG	mm ²			inches	mm	Inches	mm	
Minimum Quantity				3,000	1,000	100				
6	13.3	8	8.4	-	5912-BK	5912	0.18	4.57	0.45	11.43
6	13.3	12 to 10	3.3 to 5.3	5910-BK	-	5910	0.14	3.56	0.47	11.94
6	13.3	16 to 14	1.3 to 2.1	5913-BK	-	5913	0.09	2.29	0.47	11.94

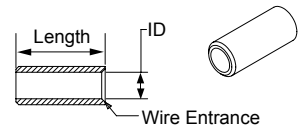

Powerpole®

Tooling Information - Anderson Power™ Applicators are Mechanical Feed Style and do not Require an Air Feed Kit.

Wire Size		Loose Piece Part Number		Loose Piece Contact Crimp Tools							
AWG	mm²	Tin Plating	Silver Plating	Hand Tool	OR	Pneumatic Bench Tool	+	Die	+	Locator	Number of Crimps
PP75											
6	13.3	N/A	1307	1309G4		1387G1		1388G6		1389G6	Single
			5900								
8	8.4	1875G1									
		5952									
		1875G2									
		5953									
10 to 12	5.3 to 3.3	N/A	1875G2					1388G7		1389G6	
			5915							1389G21	
			1875G3							1389G6	

NOTE: see website for the most current information.

All Data Subject to Change Without Notice 2024-0103 DS-PP75 REV 8 **Your Best Connection™**

Anderson™ will use reasonable efforts to include accurate and up-to-date content in the data sheet. All product information contained in the data sheet including ordering information, illustrations, specifications, and dimensions, are believed to be reliable as of the date of publishing, but is subject to change without notice. Anderson™ makes no warranty or representation as to its accuracy. Content in the data sheet may contain technical inaccuracies, typographical errors and may be changed or updated without notice. Anderson™ may also make improvements and/or changes to the products and/or to the programs described in the content at any time without notice. Current sales drawings and specifications are available upon request.

©2024 Anderson Power Products, Inc. All rights reserved. A®, and Powerpole® are registered trademarks of Anderson Power Products, Inc. Anderson™, Anderson Power™, Anderson Power™ logo and Your Best Connection™ are trademarks of Anderson Power Products, Inc.



HEADQUARTERS: Anderson Power Products®, 13 Pratts Junction Road, Sterling, MA 01564-2305 USA T: +1 978-422-3800 F: +1 978-422-0128 • **EUROPE:** Anderson Power Products® Ltd., Unit 3, Europa Court, Europa Boulevard, Westbrook, Warrington, Cheshire, WA5 7TN United Kingdom T: +44 (0) 1925 428390 F: +44 (0) 1925 520203 • **GERMANY:** IDEAL® Industries Germany GmbH, Esslinger Strasse 7, D – 70771 Leinfelden-Echterdingen, T: +49 (0) 711 – 997606666 • **ASIA / PACIFIC:** IDEAL® Anderson Asia Pacific Ltd., Unit 922-928 Topsail Plaza, 11 On Sum Street, Shatin N.T., Hong Kong T: +(852) 2636 0836 F: +(852) 2635 9036 • **INDIA:** IDEAL® INDUSTRIES India Private Limited, 229-230, SPAZEDGE, Tower B, Sector 47, Sohna Road, Gurgaon – 122018, Haryana, India T: +(91) 956-0075905 T: +(91) 124-4495101 • **CHINA:** IDEAL® Anderson Technologies (Shenzhen) Ltd., Block A8 Tantou Western Industrial Park, Songgang Baoan District, Shenzhen, PR. China 518105 T: +(86) 755 2768 2118 F: +(86) 755 2768 2218 • www.ideal-industries.in • www.andersonpower.com