

PROPRIETARY RIGHTS ARE CLAIMED FOR THE MATERIAL DISCLOSED IN THIS DRAWING.

LTR.	REVISIONS	DATE
≠	*****	00-00-98

TYP. WALL THICKNESS = 2.0

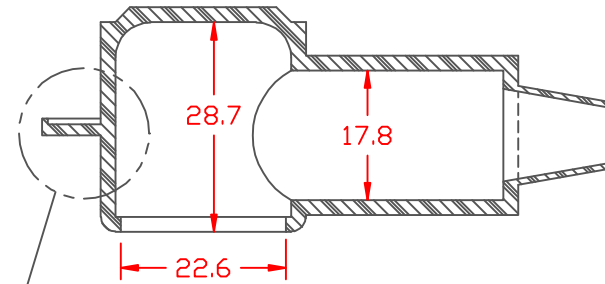

SEE VIEW "B"

SECTION A-A

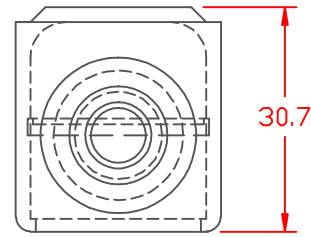

SEAL NO. 2 SHOWN

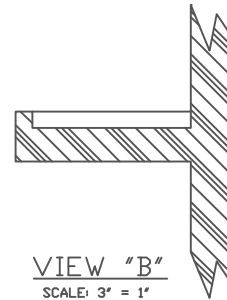
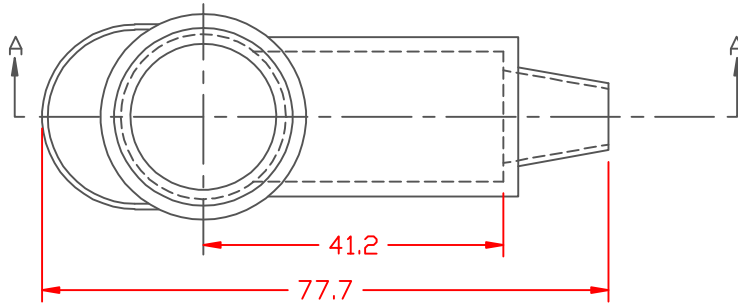

VIEW "B"  
SCALE: 3" = 1"

SEAL OPTIONS

SEAL THICKNESS = .8

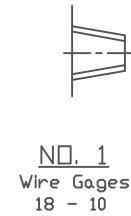

NO. 1  
Wire Gages  
18 - 10

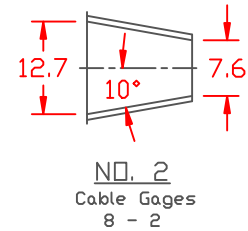

NO. 2  
Cable Gages  
8 - 2

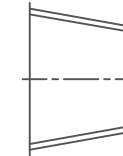

NO. 3  
Cable Gages  
2 - 2/0

TOLERANCE UNLESS OTHERWISE SPECIFIED: ±.030"/±0.8mm  
RADIAL DIAMETERS TO BE MEASURED OVER MANDRELS,  
RING GAGES OR PIN GAGES OF SUITABLE SIZE

VTE Material Part No:	1101650102
Material:	RED PVC
Material Part No:	9812-65-RED683
Max. Operating Temp:	105 C
Shore Durometer:	"A" 10 SEC. 67/62
Specific Gravity:	1.34
Ult. Elongation %:	475
Brittle Temp:	-44 C
Tensile Strength PSI:	1547 PSI
Dielectric Strength, v./ml:	540
U.L. Rating:	94 V2
MEETS:	FMVSS.302

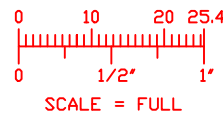

**VTE Incorporated**  
 5437 Robinson Road, P.O. Box 790  
 Pellston, Michigan 49769  
 Telephone: 1-800-527-9256, 231-539-8000  
 FAX: 231-539-0914

REF:	DATE: 3-24-98	DRN BY: JC CHK'D BY:	WEIGHT: 03 LBS. / 13.7 G.
TITLE: <b>TERMINAL INSULATOR CAP</b>			
MATERIAL:		PART NO. <b>224N2V02</b>	
COLOR:	DRG CLASS		